

Specification for Approval

Date: 2016/12/11

Customer : _____

TAI-TECH P/N: **HCB-F-Series**

CUSTOMER P/N: _____

DESCRIPTION: **High Current Ferrite Chip Bead**

QUANTITY: _____ pcs

REMARK:		
Customer Approval Feedback		

Sales Dep.

APPROVED	CHECKED
Andy Huang	Camilla Liu

R&D Center

APPROVED	CHECKED	DRAWN
Nick Chang	Vita Yeh	Alin Chang

High Current Ferrite Chip Bead(Lead Free)

HCB-F-Series

1.Features

- 1.Monolithic inorganic material construction.
- 2.Low DC resistance structure of electrode to prevent wasteful electric power consumption.
- 3.Closed magnetic circuit avoids crosstalk.
- 4.Suitable for flow and reflow soldering.
- 5.Shapes and dimensions follow E.I.A. spec.
- 6.Available in various sizes.
- 7.Excellent solderability and heat resistance.
- 8.High reliability.
- 9.This component is compliant with RoHS legislation and also support lead-free soldering.

2.Dimensions

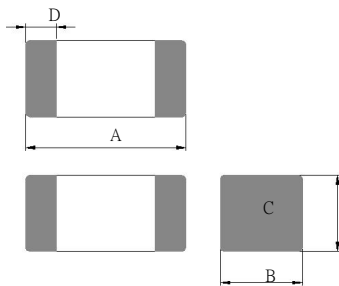

Chip size				
Size	A(mm)	B(mm)	C(mm)	D(mm)
1608	1.6±0.15	0.8±0.15	0.8±0.15	0.3±0.2
2012	2.0±0.2	1.25±0.2	0.85±0.2	0.5±0.3
3216	3.2±0.2	1.6±0.2	1.1±0.2	0.5±0.3
3225	3.2±0.2	2.5±0.2	1.3±0.2	0.5±0.3
4516	4.5±0.2	1.6±0.2	1.6±0.2	0.5±0.3
4532	4.5±0.2	3.2±0.2	1.5±0.2	0.5±0.3
5750	5.7±0.2	5.0±0.3	1.8±0.2	0.5±0.3

3.Part Numbering

HC **1608** **KF** - **121** **T** **20**

A B C D E F

A: Series
 B: Dimension L x W
 C: Material Lead Free Material
 D: Impedance 121=120Ω
 E: Packaging T=Taping and Reel, B=Bulk(Bags)
 F: Rated Current 20=2000mA

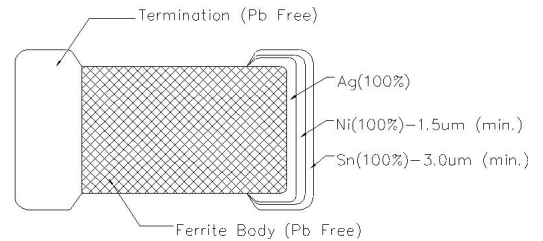

4.Specification

Tai-Tech Part Number	Impedance (Ω)	Test Frequency (MHz)	DC Resistance (Ω) max.	Rated Current (mA)
HC1608KF-300T30	30±25%	100	0.04	3000
HC1608KF-800T30	80±25%	100	0.04	3000
HC1608KF-121T20	120±25%	100	0.10	2000
HC1608KF-151T20	150±25%	100	0.10	2000
HC1608KF-221T20	220±25%	100	0.10	2000
HC1608KF-301T10	300±25%	100	0.20	1000
HC1608KF-471T10	470±25%	100	0.20	1000
HC1608KF-601T10	600±25%	100	0.20	1000
HC2012KF-300T30	30±25%	100	0.04	3000
HC2012KF-800T30	80±25%	100	0.04	3000
HC2012KF-121T20	120±25%	100	0.10	2000
HC2012KF-151T20	150±25%	100	0.10	2000
HC2012KF-221T20	220±25%	100	0.10	2000
HC2012KF-301T10	300±25%	100	0.20	1000
HC2012KF-471T10	470±25%	100	0.20	1000

TAI-TECH

Tai-Tech Part Number	Impedance (Ω)	Test Frequency (MHz)	DC Resistance (Ω) max.	Rated Current (mA)
HCB2012KF-601T10	600 \pm 25%	100	0.20	1000
HCB3216KF-300T30	30 \pm 25%	100	0.04	3000
HCB3216KF-500T30	50 \pm 25%	100	0.04	3000
HCB3216KF-800T30	80 \pm 25%	100	0.04	3000
HCB3216KF-121T20	120 \pm 25%	100	0.10	2000
HCB3216KF-151T20	150 \pm 25%	100	0.10	2000
HCB3216KF-301T10	300 \pm 25%	100	0.20	1000
HCB3216KF-471T10	470 \pm 25%	100	0.20	1000
HCB3216KF-501T30	500 \pm 25%	100	0.04	3000
HCB3216KF-601T20	600 \pm 25%	100	0.10	2000
HCB3225KF-600T40	60 \pm 25%	100	0.03	4000
HCB3225KF-900T20	90 \pm 25%	100	0.10	2000
HCB3225KF-151T50	150 \pm 25%	100	0.02	5000
HCB3225KF-201T40	200 \pm 25%	100	0.03	4000

5. Reliability and Test Condition

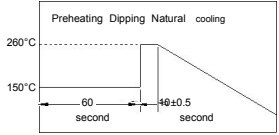
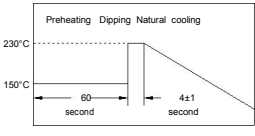
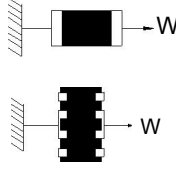
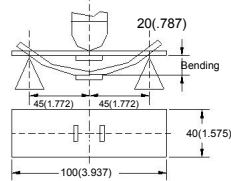
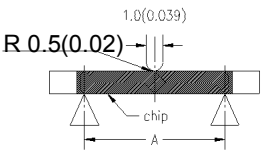
Item		Performance									Test Condition																											
Series No.	FCB	FCM	HCB	HPB	HFB	FCA	FCI	FHI	FCH	HCI																												
Operating Temperature	-55~+125°C						-40~+85°C				--																											
Storage Temperature	-55~+125°C						-40~+85°C				--																											
Impedance (Z)	Refer to standard electrical characteristics list										HP4291A, HP4287A+16092A																											
Inductance (Ls)																																						
Q Factor																																						
DC Resistance												HP4338B																										
Rated Current												**																										
Temperature Rise Test	30°C max. (T)										1. Applied the allowed DC current. 2. Temperature measured by digital surface thermometer.																											
Solder heat Resistance	Appearance: No significant abnormality. Impedance change: Within ± 30%.					No mechanical damage. Remaining terminal electrode:70% min.					Preheat: 150°C, 60sec. Solder: Sn-Ag3.0-Cu0.5 Solder temperature: 260±5°C Flux for lead free: rosin Dip time: 10±0.5sec. 																											
Solderability	More than 90% of the terminal electrode should be covered with solder.										Preheat: 150°C, 60sec. Solder: Sn-Ag3.0-Cu0.5 Solder temperature: 230±5°C Flux for lead free: rosin Dip time: 4±1sec.																											
Terminal strength	The terminal electrode and the dielectric must not be damaged by the forces applied on the right conditions.										For FCB FCM HCB HPB HFB FCI FHI FCH HCI: Size Force (Kfg) Time(sec) 1005 0.2 1608 0.5 2012 0.6 3216 1.0 >25 3225 1.0 4516 1.0 4532 1.5 5750 2.0 For FCA: Size Force (Kfg) Time(sec) 3216 0.5 >25																											
Flexure strength	The terminal electrode and the dielectric must not be damaged by the forces applied on the right conditions.										Solder a chip on a test substrate, bend the substrate by 2mm (0.079in) and return.																											
Bending Strength	The ferrite should not be damaged by Forces applied on the right condition.										<table border="1"> <thead> <tr> <th>Size</th> <th>mm(inches)</th> <th>P-Kgf</th> </tr> </thead> <tbody> <tr> <td>1608</td> <td>0.80(0.033)</td> <td>0.3</td> </tr> <tr> <td>2012</td> <td>1.40(0.055)</td> <td>1.0</td> </tr> <tr> <td>FCA3216</td> <td>2.00(0.079)</td> <td>1.5</td> </tr> <tr> <td>3216</td> <td>2.00(0.079)</td> <td>2.5</td> </tr> <tr> <td>3225</td> <td>2.00(0.079)</td> <td>2.5</td> </tr> <tr> <td>4516</td> <td>2.70(0.106)</td> <td>2.5</td> </tr> <tr> <td>4532</td> <td>2.70(0.106)</td> <td>2.5</td> </tr> <tr> <td>5750</td> <td>2.70(0.106)</td> <td>2.5</td> </tr> </tbody> </table>	Size	mm(inches)	P-Kgf	1608	0.80(0.033)	0.3	2012	1.40(0.055)	1.0	FCA3216	2.00(0.079)	1.5	3216	2.00(0.079)	2.5	3225	2.00(0.079)	2.5	4516	2.70(0.106)	2.5	4532	2.70(0.106)	2.5	5750	2.70(0.106)	2.5
Size	mm(inches)	P-Kgf																																				
1608	0.80(0.033)	0.3																																				
2012	1.40(0.055)	1.0																																				
FCA3216	2.00(0.079)	1.5																																				
3216	2.00(0.079)	2.5																																				
3225	2.00(0.079)	2.5																																				
4516	2.70(0.106)	2.5																																				
4532	2.70(0.106)	2.5																																				
5750	2.70(0.106)	2.5																																				
Random Vibration Test	Appearance: Cracking, shipping and any other defects harmful to the characteristics should not be allowed. Impedance: within±30%					Frequency: 10-55-10Hz for 1 min. Amplitude: 1.52mm Directions and times: X, Y, Z directions for 2 hours. A period of 2 hours in each of 3 mutually perpendicular directions (Total 6 hours).																																
Drop	Drop 10 times on a concrete floor from a height of 75cm					a: No mechanical damage b: Impedance change: ±30%																																

Item	Performance	Test Condition
Loading at High Temperature	Appearance: no damage.	Temperature: 125±5°C (bead), 85±5°C (inductor) Applied current: rated current. Duration: 500±12hrs. Measured at room temperature after placing for 2 to 3hrs.
Humidity	Impedance: within±30%of initial value. Inductance: within±10%of initial value. Q: within±30%of initial value. (FCI FHI FCH) Q: within±20%of initial value. (HCI)	Humidity: 90~95%RH. Temperature: 40±2°C. Temperature: 60±2°C.(HCI) Duration: 500±12hrs. Measured at room temperature after placing for 2 to 3hrs.
Thermal shock	Appearance: no damage. Impedance: within±30%of initial value. Inductance: within±10%of initial value. Q: within±30%of initial value. (FCI FHI FCH) Q: within±20%of initial value. (HCI)	For FCB FCM HCB HPB HFB FCA : Condition for 1 cycle Step1: -55±2°C 30±3 min. Step2: +125±5°C 30±3 min. Number of cycles: 5 For FCI FHI FCH HCI : Condition for 1 cycle Step1: -40±2°C 30±3 min. Step2: +85±5°C 30±3 min. Number of cycles: 100 Measured at room temperature after placing for 2 to 3 hrs.
Low temperature storage test		Temperature: -55±2°C. Duration: 500±12hrs. Measured at room temperature after placing for 2 to 3hrs.
Drop	Drop 10 times on a concrete floor from a height of 75cm	a: No mechanical damage b: Impedance change: ±30%

****Derating Curve**

For the ferrite chip bead which withstanding current over 1.5A, as the operating temperature over 85°C, the derating current information is necessary to consider with. For the detail derating of current, please refer to the Derated Current vs. Operating Temperature curve.

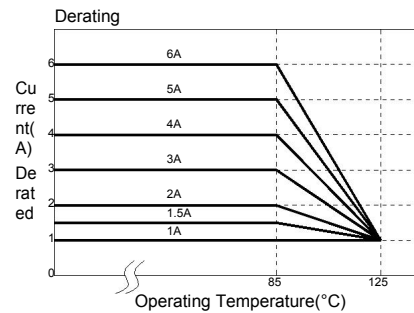

6.Soldering and Mounting

6-1. Recommended PC Board Pattern

Series	Type	Chip Size				Land Patterns For Reflow Soldering		
		A(mm)	B(mm)	C(mm)	D(mm)	L(mm)	G(mm)	H(mm)
FCB	1005	1.0±0.10	0.50±0.10	0.50±0.10	0.25±0.10	2.10	0.50	0.55
FCM	1608	1.6±0.15	0.80±0.15	0.80±0.15	0.30±0.20	2.60	0.60	0.80
HCB	2012	2.0±0.20	1.25±0.20	0.85±0.20	0.50±0.30	3.00	1.00	1.00
		2.0±0.20	1.25±0.20	1.25±0.20	0.50±0.30			
HFB	2520	2.5±0.20	2.00±0.20	1.60±0.20	0.50±0.30	3.90	1.50	1.50
FCI	3216	3.2±0.20	1.60±0.20	1.10±0.20	0.50±0.30	4.40	2.20	1.40
FHI	3225	3.2±0.20	2.50±0.20	1.30±0.20	0.50±0.30	4.40	2.20	3.40
FCH	4516	4.5±0.20	1.60±0.20	1.60±0.20	0.50±0.30	5.70	2.70	1.40
HCI	4532	4.5±0.20	3.20±0.20	1.50±0.20	0.50±0.30	5.90	2.57	4.22
UHI	5750	5.7±0.20	5.00±0.30	1.80±0.20	0.50±0.30	8.00	4.00	5.80

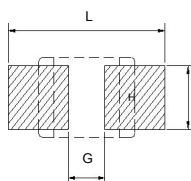
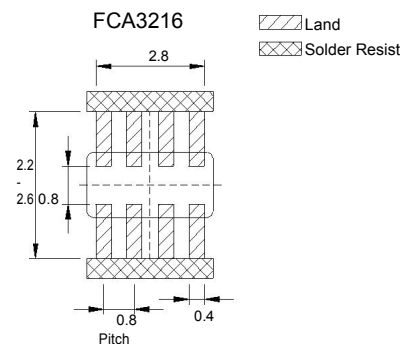

PC board should be designed so that products are not sufficient under mechanical stress as warping the board. Products shall be positioned in the sideway direction against the mechanical stress to prevent failure.

6-2. Soldering

Mildly activated rosin fluxes are preferred. The minimum amount of solder can lead to damage from the stresses caused by the difference in coefficients of expansion between solder, chip and substrate. The terminations are suitable for all wave and re-flow soldering systems. If hand soldering cannot be avoided, the preferred technique is the utilization of hot air soldering tools.

6-2.1 Lead Free Solder re-flow:

Recommended temperature profiles for lead free re-flow soldering in Figure 1.

6-2.2 Solder Wave:

Wave soldering is perhaps the most rigorous of surface mount soldering processes due to the steep rise in temperature seen by the circuit when immersed in the molten solder wave, typical at 230°C. Due to the risk of thermal damage to products, wave soldering of large size products is discouraged. Recommended temperature profile for wave soldering is shown in Figure 2.

6-2.3 Soldering Iron(Figure 3):

Products attachment with a soldering iron is discouraged due to the inherent process control limitations. In the event that a soldering iron must be employed the following precautions are recommended.

- Note :
- Preheat circuit and products to 150°C
 - Never contact the ceramic with the iron tip
 - Use a 20 watt soldering iron with tip diameter of 1.0mm
 - 350°C tip temperature for Ferrite chip bead (max)
 - 1.0mm tip diameter (max)
 - Limit soldering time to 3 sec.

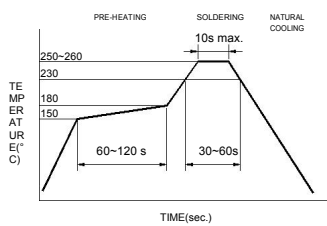

Figure 1. Re-flow Soldering(Lead Free)

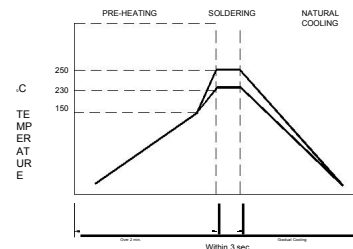

Figure 2. Wave Soldering

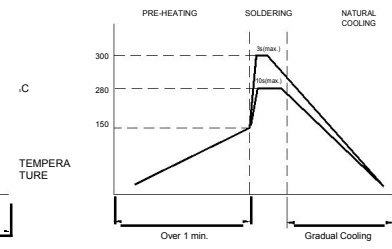
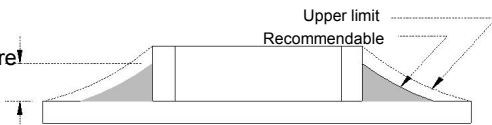

Figure 3. Hand Soldering

6-2.4 Solder Volume:

Accordingly increasing the solder volume, the mechanical stress to product is also increased. Exceeding solder volume may cause the failure of mechanical or electrical performance. Solder shall be used not to be exceed as shown in right side:



7. Packaging Information

7-1. Reel Dimension

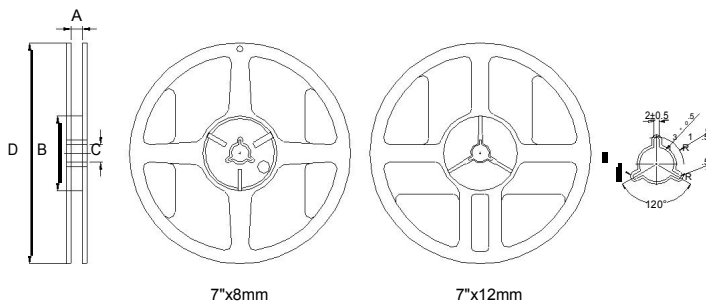

Type	A(mm)	B(mm)	C(mm)	D(mm)
7"x8mm	9.0±0.5	60±2	13.5±0.5	178±2
7"x12mm	13.5±0.5	60±2	13.5±0.5	178±2

7-2.1 Tape Dimension / 8mm

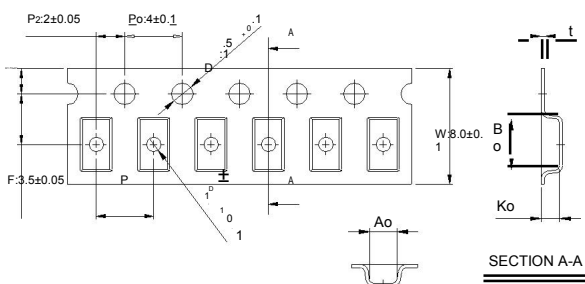

Series	Size	Bo(mm)	Ao(mm)	Ko(mm)	P(mm)	t(mm)	D1(mm)
FCB,FCM	100505	1.12±0.05	0.67±0.05	0.54±0.05	2.0±0.1	0.23±0.05	none
HCB,HPB	160808	1.80±0.10	1.01±0.10	1.02±0.10	4.0±0.1	0.22±0.05	none
HFB	201209	2.25±0.10	1.42±0.10	1.04±0.10	4.0±0.1	0.22±0.05	1.0±0.1
FCI	201212	2.35±0.10	1.50±0.10	1.45±0.10	4.0±0.1	0.22±0.05	1.0±0.1
FHI, FCH	321611	3.50±0.10	1.88±0.10	1.27±0.10	4.0±0.1	0.22±0.05	1.0±0.1
HCI	322513	3.42±0.10	2.77±0.10	1.55±0.10	4.0±0.1	0.22±0.05	1.0±0.1
FCA	321609	3.40±0.10	1.77±0.10	1.04±0.1	4.0±0.10	0.22±0.05	1.0±0.1

7-2.2 Tape Dimension / 12mm

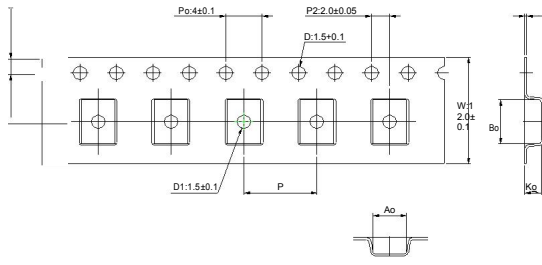

Series	Size	Bo(mm)	Ao(mm)	Ko(mm)	P(mm)	t(mm)	D1(mm)
FCB,	451616	4.95 ± 0.1	1.93 ± 0.1	1.93 ± 0.1	4.0 ± 0.1	0.24 ± 0.05	1.5 ± 0.1
HC.B.FCM	453215	4.95 ± 0.1	3.66 ± 0.1	1.85 ± 0.1	8.0 ± 0.1	0.24 ± 0.05	1.5 ± 0.1
FCI	575018	6.10 ± 0.1	5.40 ± 0.1	2.00 ± 0.1	8.0 ± 0.1	0.30 ± 0.05	1.5 ± 0.1

7-3. Packaging Quantity

Chip Size	575018	453215	451616	322513	321611	201212	201209	160808	100505
Chip / Reel	1000	1000	2000	2500	3000	2000	4000	4000	10000
Inner box	4000	4000	8000	12500	15000	10000	20000	20000	50000
Middle box	20000	20000	40000	62500	75000	50000	100000	100000	250000
Carton	40000	40000	80000	125000	150000	100000	200000	200000	500000
Bulk (Bags)	7000	12000	20000	30000	50000	100000	150000	200000	300000

7-4. Tearing Off Force

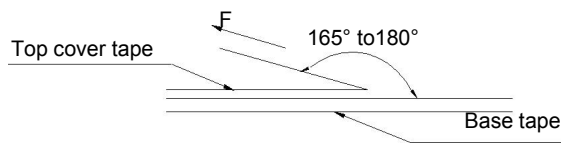

The force for tearing off cover tape is 15 to 60 grams in the arrow direction under the following conditions.

Room Temp. (°C)	Room Humidity (%)	Room atm (hPa)	Tearing Speed mm/min
5~35	45~85	860~1060	300

Application Notice

- Storage Conditions

To maintain the solderability of terminal electrodes:

1. Temperature and humidity conditions: -10~ 40°C and 30~70% RH.
2. Recommended products should be used within 6 months from the time of delivery.
3. The packaging material should be kept where no chlorine or sulfur exists in the air.

- Transportation

1. Products should be handled with care to avoid damage or contamination from perspiration and skin oils.
2. The use of tweezers or vacuum pick up is strongly recommended for individual components.
3. Bulk handling should ensure that abrasion and mechanical shock are minimized.